



### PRODUCT DETAILS

The BiANCO NXT SB4 water filled 4" bore pumps represent exceptional value and are an excellent choice for delivering water reliably from bores or water wells. Supplied with capacitor and NXT iProtect protection and control box

#### MOTOR FEATURES

- Asynchronous two-pole electric motor made entirely of stainless steel for the parts in contact with water.
- The thrust block and bushes are cooled and lubricated with a mixture of water and glycol.
- Filter check valve and pressure equalising diaphragm
- The stator is housed in an airtight stainless steel casing and resin filled using the Stator Shield system.
- Equipped with surge arrestors to provide maximum protection against lightning, transient and voltage surge conditions.
- Removable water bloc lead.
- Industry standard NEMA mounting dimensions.

#### WET-END FEATURES

- Floating Impeller Stack and Face Clearance Design allows sand and abrasive particles to pass freely ensuring optimum resistance against wear.
- Integrated thrust washer prevents face to face contact.
- High quality wear resistant composite materials and 304 grade SS bowls, discharge head/motor adapter and plate type NRV.
- NEMA spline and stainless steel shaft.

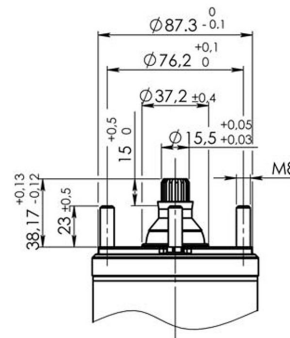

### TECHNICAL DATA

<b>RATED POWER (W)</b>	1.5 kW
<b>RATED VOLTAGE</b>	230V +10% - 6% 50Hz
<b>RATED CURRENT</b>	13.2 amps
<b>CAPACITOR</b>	40uF
<b>MAX LIQUID TEMPERATURE</b>	40°C
<b>MAX. IMMERSION DEPTH</b>	IP68 - 100m
<b>MOTOR DUTY</b>	S1 Continuous
<b>MOTOR PROTECTION LEVEL</b>	Class B
<b>SEALS</b>	High Quality Mechanical Seal

<b>MAX HEAD</b>	90m
<b>MAX FLOW</b>	9m3/hr
<b>MAX SAND CONTENT</b>	250gm3
<b>IMPELLERS</b>	Glass filled Noryl
<b>DIFFUSER</b>	Glass filled Polycarbonate
<b>NUMBER OF STAGES</b>	14
<b>LENGTH</b>	Motor 410mm Wet-end 602mm
<b>OUTLET</b>	1.25" BSPF
<b>WEIGHT (KG)</b>	Motor 16kg Wet-end 5.8kg

## CURVE

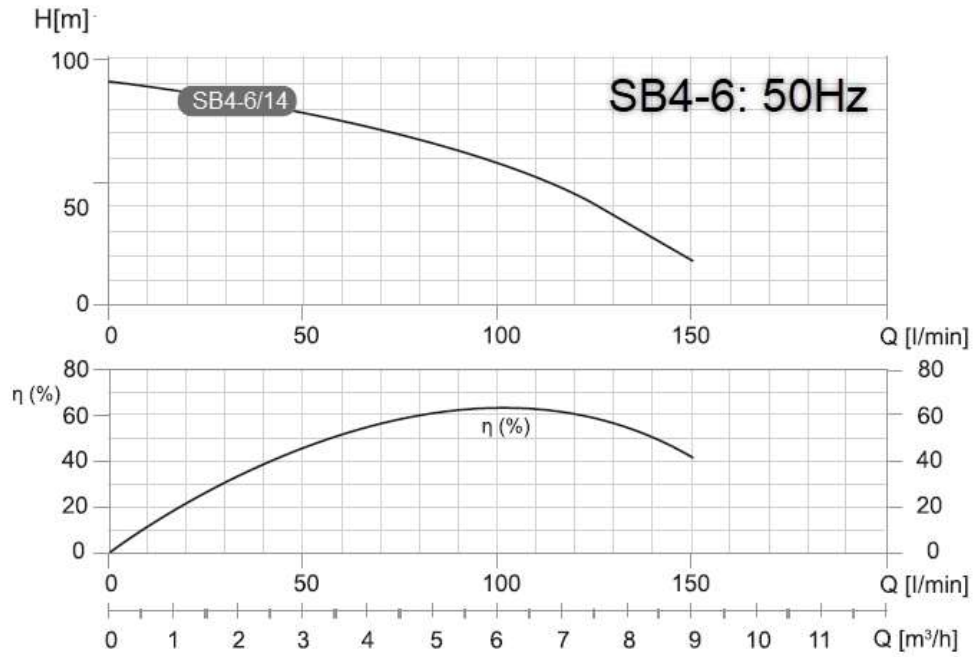

## DIMENSIONS

1	Sleeve	SS
2 & 3	2: Lower support/motor adapter and 3: discharge head	Cast SS
4	Shaft with coupling	SS
5	Intermediate support	Glass filled composite
6	Bowl	SS
7	7: Impeller	Glass filled Noryl
8, 9	8: Diffusers 9: Top Diffuser	Glass filled Polycarbonate
10	Intermediate bearing	NBR
11 - 14	11: Shaft bushing 12: Top bushing 13: Adapter ring 14: NRV cap	SS
16	NVR support and O-ring	SS and NBR
17 - 23	17: NRV lock ring 18: Filter 19: Cable guard 21: Upper split ring 23: Thrust washer	SS

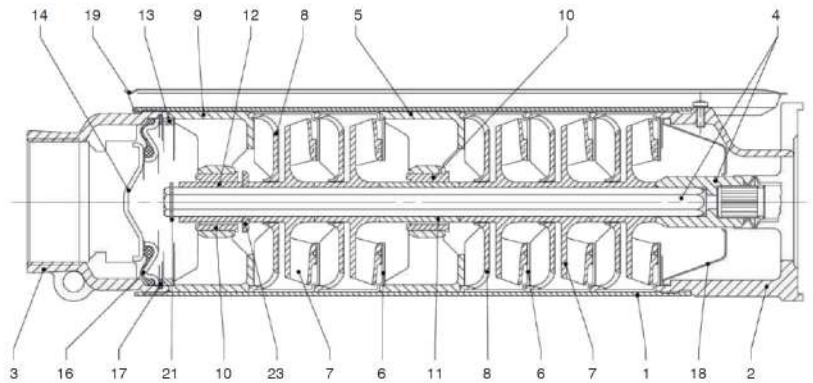

## WARRANTY / CERTIFICATIONS

